

# Cost-effective & Flexible Solution



2260 Investigator *Systems & Kits*

Brüel & Kjær 

# 2260 INVESTIGATOR™

This hand-held, 2-channel analyzer's ever-growing suite of dedicated software and the acoustically "stream-lined" design provide solutions for a wide range of measurement and analysis problems, making it the perfect tool for even the most discriminating acoustic specialist. Generous hardware and software specifications make Type 2260 an extremely flexible instrument that can cover all your sound analysis needs.

Please browse through this leaflet and find the solution that suits your specific needs.



## 2260 Investigator Systems

2260 Investigator Systems include 2260 Investigator, calibrator\*, tripod, serial interface cable and windscreen, as well as all the necessary equipment for your particular application.

## 2260 Investigator Kits

2260 Investigator Kits are for those of you who already own a 2260 Investigator. The kits include all the necessary equipment for your particular application.

*\* Not included with the Sound Intensity System*

# 2260 BASIC SYSTEM

## General Noise Analysis

### Sound Analysis in your Hand and on your PC (Windows®)

2260 Investigator is a versatile, hand-held, battery-operated, two-channel sound analyzer comprising hardware and embedded operating-system software. It is the ideal platform for high-quality, real-time sound analyses. Like a personal computer, it is driven by application software for various tasks.

### Uses

- Comprehensive sound measurement
- Detailed octave and 1/3-octave band analyses
- Appraisal of noise reduction efforts
- Gathering field-data for further analyses
- Research and development

### Features

- IEC and ANSI Type 1 sound level meter
- Real-time octave and 1/3-octave band analyses
- Multi-language (GB, D, F, I, E, CZ) user interface with context-sensitive, on-line help
- Broadband statistics

## 2260 Basic System

### Type 2260-102

2260 Investigator (with BZ 7210)

4231 Sound Level Calibrator

UA 0801 Lightweight Tripod

KE 0371 Carrying Case

7815 Noise Explorer™, PC Software

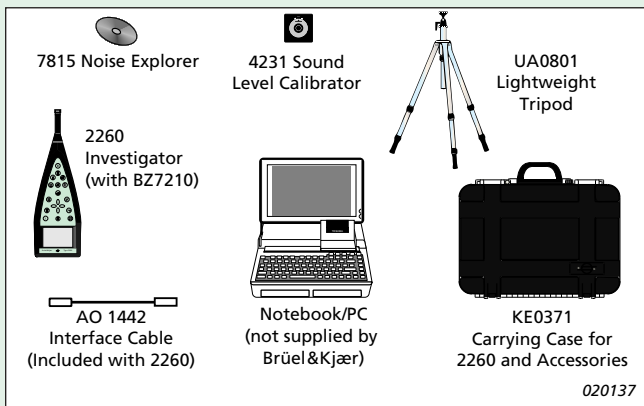

# SOUND INTENSITY

## Sound Power – Noise Source Location – Building Acoustics

The world's easiest and fastest way to make sound power measurements, noise source location, and leakage detection within building acoustics.















### One person – Hand-held – Complete Measurements

The powerful combination of 2260 Investigator, BZ 7205 software, and Sound Intensity Probe Kit Type 3595 makes it possible for you to make intensity measurements for sound power, source location and building acoustics. Automatic measurement guidance and aural feedback during measurements enable you to concentrate on making a smooth scan of the area under investigation.

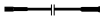
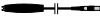
The Hand-held Sound Intensity System produces on-the-spot analyses of sound power and intensity.

### Uses

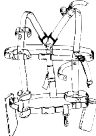
- Determines sound power with or without predefined surfaces and segmentation
- Sound power measurements in accordance with ISO 9614–2, ECMA–160 and ANSI S12.12

3595 Sound Intensity Probe Kit for 2260					
 QA 0224 Chalk	 QA 0225 Tape Measure	 DP 0888 Intensity Adaptor for 4231	 HT 0015 Earphones	 AO 0522 Headphone Adaptor for 2260	
 UA 0781 Ellipsoidal Windscreens	 4197 Sound Intensity Microphone Pair	 2683 Dual Preamplifier	 UA1439 Extension Stem	 UA1440 Handle with Integral Cable	
 KE 0379 Carrying Case for 2260 and Probe Kit		 BZ7205			 7815 Noise Explorer
 Notebook/PC (not supplied by Brüel&Kjær)	 DH 0713 Harness for 2260		 2260E Investigator (with BZ7210, BZ7205)	 AO1442 Interface Cable (Included with 2260)	

- Noise source location and noise mapping
- Building acoustics measurements (Sound Reduction Index) in accordance with ISO/DIS 15186–1 and ISO 717–1

## Features

- Complete hand-held, single unit sound intensity system
- Designed for practical field measurements
- Segmentation of measurement surfaces
- Visual and aural feedback during measurements
- Detailed information regarding the quality of the sound field
- On-site calculation and display of measurement results
- Real-time octave and 1/3-octave analysis
- General dual-channel analyzer
- Frequency range of 50 Hz to 10 kHz using a 12 mm spacer
- Built-in noise generator for building acoustics measurements
- Visual data manager for easy bookkeeping
- Basic Sound Analysis software (BZ 7210) included with 2260 Investigator

### **2260 Sound Intensity System Type 2260E – 102**

2260E Investigator (with BZ 7210, BZ 7205)  
3595 Sound Intensity Probe Kit for 2260  
DH 0713 Harness for 2260  
7815 Noise Explorer, PC Software

### **2260 Sound Intensity Kit Type BZ 7205 – 102**

BZ 7205 Sound Intensity Software  
3595 Sound Intensity Probe Kit  
DH 0713 Harness for 2260  
7815 Noise Explorer, PC Software

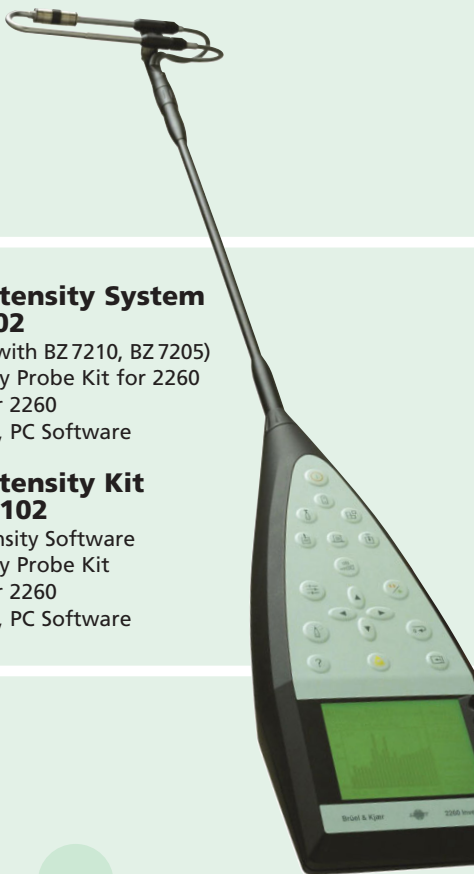



# OUTDOOR GEAR

## Noise Monitoring

### Weatherproof Measurements

Noise monitoring in out-of-the-way places need no longer be problematic. Outdoor Gear Type 3592 offers security and weather-protection for 2260 Investigator converting it into an all-weather noise monitoring system. Safe and dry in its robust, heat-reflecting, bright yellow case, the analyzer will operate unattended for more than 3 days. For longer periods, the battery can be changed without interrupting measurements. You can also save yourself a site visit by using the modem dial-up facility to collect your results.

### Uses

- Semi-permanent noise monitoring
- Noise control
- Area planning
- Complaint investigation
- Plant noise measurement
- Tamperproof workplace noise analysis
- Modem dial-up facility

### Features

- Weatherproof case and microphone system
- Fulfils IEC Type 1 and ANSI Type 2 requirements
- Interface to DAT recorder for documenting noise events
- 3 days monitoring using auxiliary 12 V battery
- Battery change without downtime
- Dynamic range 17 dB(A) to 150 dB pk
- CIC check for reliable measurements
- Packs into one case for easy transport and setup

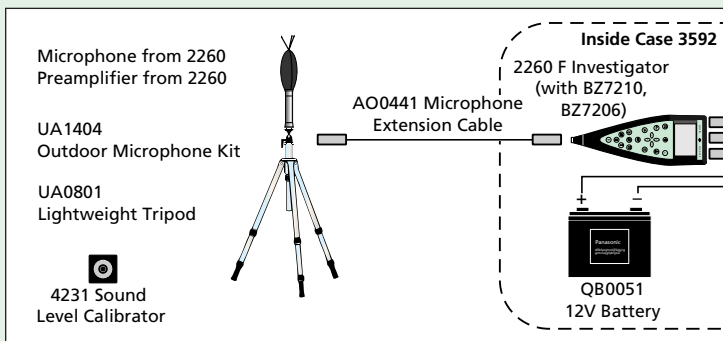

## 2260 Outdoor Gear System Type 2260F-003

- 2260F Investigator (with BZ 7210, BZ 7206)
- 4231 Sound Level Calibrator
- UA 0801 Lightweight Tripod
- AO 0441 Microphone Extension Cable
- 3592 Outdoor Gear (Case)
- UA 1404 Outdoor Microphone Kit
- QB 0051 12 V Battery
- ZG 0404 Battery Charger
- AQ 1698 Cable for 12 V Supply
- AQ 1700 Cable for DAT Remote
- AO 0543 DAT Signal Cable
- 7820 Evaluator™, PC Software

## 2260 Outdoor Gear Kit Type BZ 7206-002

- BZ 7206 Enhanced 20 kHz Sound Analysis Software
- 3592 Outdoor Gear (Case)
- UA 1404 Outdoor Microphone Kit
- QB 0051 12 V Battery
- ZG 0404 Battery Charger
- AQ 1698 Cable for 12 V supply
- AQ 1700 Cable for DAT Remote
- AO 0543 DAT Signal Cable
- AO 0441 Microphone Extension Cable
- 7820 Evaluator, PC Software

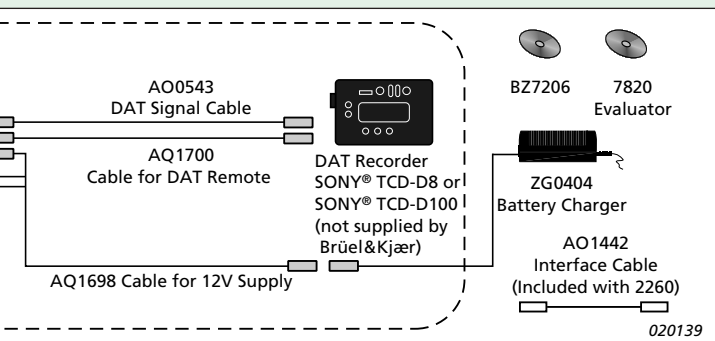



# BUILDING ACOUSTICS

## Pressure Method

### Robust – Lightweight – Instant Analysis

Architectural and building acoustic measurements require a powerful, rugged and reliable amplifier and loudspeaker system. The system must also be light, portable and easy to set up and dismantle. Brüel & Kjær has just the equipment to satisfy these demands.

### Basic System Uses

- Reducing hazardous noise in the workplace
- Reducing noise annoyance in apartment blocks
- Improving acoustical comfort in private and public buildings
- Reverberation time measurement

### Features

- Measures 1/1- and 1/3-octave reverberation time
- Fast measurement of all frequency bands simultaneously
- Interrupted noise or impulse excitation
- Backward integrated impulse decays (Schroeder method)
- Built-in pink or white noise generator
- PC software for editing, reporting and archiving

## 2260 Basic Building Acoustics System Type 2260G – 001 (Reverberation Time only)

2260G Investigator (with BZ 7210, BZ 7207)

4231 Sound Level Calibrator

UA 0801 Lightweight Tripod

7831 Qualifier Light™, PC Software



2260G  
Investigator  
(with BZ7210,  
BZ7207)

AO1442  
Interface Cable  
(Included with 2260)



4231  
Sound Level  
Calibrator



7831 Qualifier  
Light, PC software

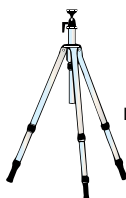

UA0801  
Lightweight  
Tripod

020144



## Standard System Uses (in addition to those of Basic System)

- Airborne sound insulation
- Façade sound insulation
- Impact sound insulation (with Tapping Machine Type 3207)

## Features (in addition to those of Basic System)

- Complete hand-held building acoustics analyzer
- Measures 1/1- and 1/3-octave bands in real-time
- Measures level and reverberation time spectra
- Can make serial measurements for background noise suppression
- Calculates sound insulation curves and indices on the spot
- Fulfils ISO and national standards
- Supports wireless transmission

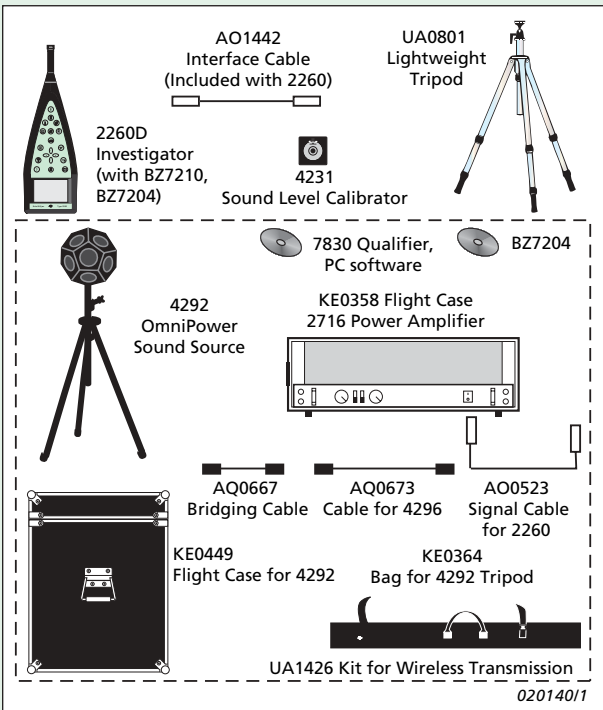

## 2260 Standard Building Acoustics System Type 2260D – 001

- 2260D Investigator (with BZ 7210, BZ 7204)
- 4231 Sound Level Calibrator
- UA 0801 Lightweight Tripod
- 2716 Power Amplifier
- 4292 OmniPower Sound Source
- UA 1426 Kit for Wireless Transmission
- AO 0523 Signal Cable for 2260
- AQ 0667 Bridging Cable
- AQ 0673 Cable for 4292
- KE 0358 Flight Case (for 2716)
- KE 0364 Carrying Bag (for 4292 Tripod)
- KE 0449 Flight Case (for 4292)
- 7830 Qualifier™, PC Software

## 2260 Standard Building Acoustics Kit Type BZ 7204 – 001

- BZ 7204 Building Acoustics Software
- 2716 Power Amplifier
- 4292 OmniPower Sound Source
- UA 1426 Kit for Wireless Transmission
- AO 0523 Signal Cable for 2260
- AQ 0667 Bridging Cable
- AQ 0673 Cable for 4292
- KE 0358 Flight Case (for 2716)
- KE 0364 Carrying Bag (for 4292 Tripod)
- KE 0449 Flight Case (for 4292)
- 7830 Qualifier, PC Software

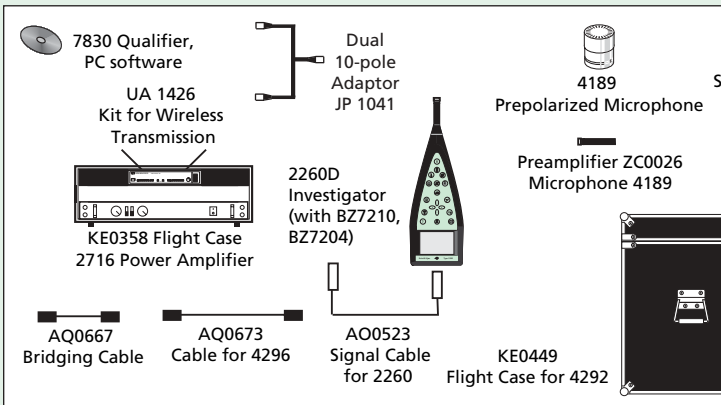

## Advanced System

### Uses (in addition to those of Standard System)

- Single- or dual-channel measurement of airborne sound insulation
- Façade sound insulation using traffic noise

### Features (in addition to those of Standard System)

- Measures 2-channels simultaneously in 1/3- or 1/1-octave bands

## 2260 Advanced Building Acoustics System Type 2260D – 002

2260D Investigator (with BZ 7210, BZ 7204)

4231 Sound Level Calibrator

3 x UA 0801 Lightweight Tripod

2716 Power Amplifier

4292 OmniPower Sound Source

4189 Prepolarized Microphone

ZC 0026 Preamplifier

2 x UA 1317 Microphone Holder

3 x AO 0442 10 m Microphone Extension Cable

UA 1426 Kit for Wireless Transmission

AO 0523 Signal Cable for 2260

AQ 0667 Bridging Cable

AQ 0673 Cable for 4292

JP 1041 Dual 10-pole Adaptor

AR 0199 10-pin Flat Cable

KE 0358 Flight Case (for 2716)

KE 0364 Carrying Bag (for 4292 Tripod)

KE 0449 Flight Case (for 4292)

7830 Qualifier, PC Software

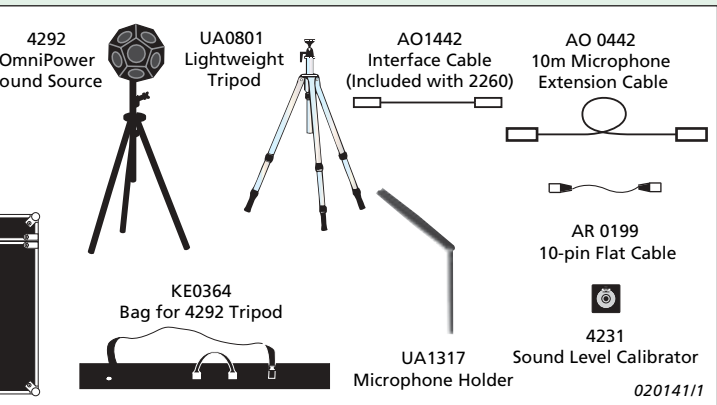

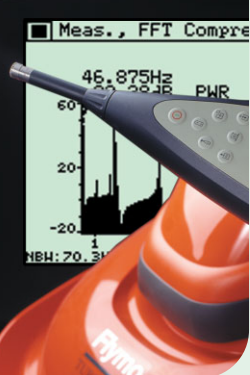

# FFT AND PURE TONE ANALYSIS

## Fourier at your Fingertips

Use BZ 7208 FFT software with your 2260 Investigator for sound or vibration FFT analysis. Suitable for machinery investigation, troubleshooting, pure-tone investigation, product development, quality control, and building-vibration analysis. This hand-held FFT analysis system gives you single-channel, real-time operation with internal and external triggers.

## Uses

- FFT analysis of sound or vibration
- Machinery troubleshooting
- Pure-tone investigation for environmental noise measurements
- Product development
- Quality control
- Building-vibration analysis

## Features

- Hand-held FFT analysis of sound or vibration
- Single-channel analysis
- Real-time operation (no data loss)
- Internal and external trigger
- Measures transient and continuous signals
- Max. frequency span of 20 kHz; min. frequency span of 156 Hz
- Over 400 lines
- Zoom down to better than 0.5 Hz resolution
- FFT auto-spectrum Lin or A-weighted
- Compare spectrum to stored reference
- PC software for analysis, reporting and archiving

**2260 ENV System  
Type 2260H – 001**

- 2260H Investigator (with BZ 7210, BZ 7208)
- BZ 7206 Enhanced 20 kHz Sound Analysis Software
- 7820 Evaluator, PC Software
- 4231 Sound Level Calibrator
- AO 0586 Audio Cable, 3 m
- UA 0801 Lightweight Tripod
- KE 0371 Carrying Case

**2260 ENV Kit  
Type BZ 7208 – 001**

- BZ 7208 FFT Software
- BZ 7206 Enhanced 20 kHz Sound Analysis Software
- 7820 Evaluator, PC Software
- 4231 Sound Level Calibrator
- AO 0586 Audio Cable, 3 m
- UA 0801 Lightweight Tripod
- KE 0371 Carrying Case

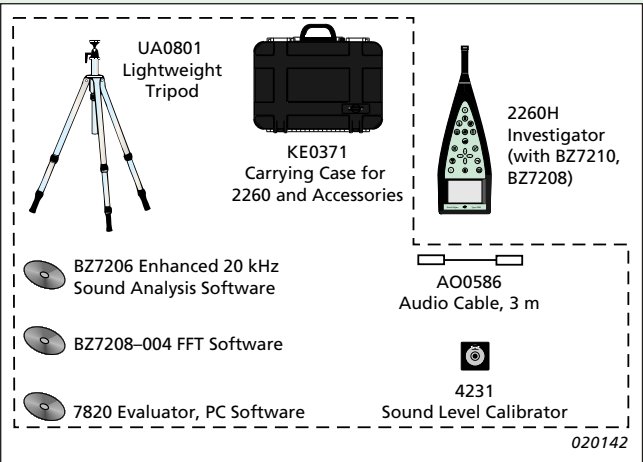

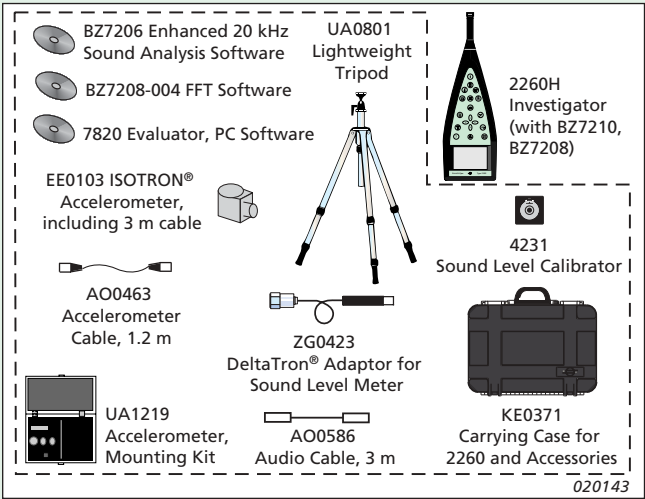

## 2260 ENV System incl. Vibration Type 2260H – 002

2260H Investigator (with BZ 7210, BZ 7208)  
 BZ 7206 Enhanced 20 kHz Sound Analysis Software  
 7820 Evaluator, PC Software  
 4231 Sound Level Calibrator  
 AO 0586 Audio Cable, 3 m  
 UA 0801 Lightweight Tripod  
 KE 0371 Carrying Case  
 AO 0463 Accelerometer Cable, 1.2 m  
 EE 0103 ISOTRON® Accelerometer, including 3 m cable  
 UA 1219 Accelerometer Mounting Kit  
 ZG 0423 DeltaTron® Adaptor for Sound Level Meter

## 2260 ENV Kit incl. Vibration BZ 7208 – 002

BZ 7208 – 004 FFT Software  
 BZ 7206 Enhanced 20 kHz Sound Analysis Software  
 7820 Evaluator, PC Software  
 4231 Sound Level Calibrator  
 AO 0586 Audio Cable, 3 m  
 UA 0801 Lightweight Tripod  
 KE 0371 Carrying Case  
 AO 0463 Accelerometer Cable, 1.2 m  
 EE 0103 ISOTRON® Accelerometer, including 3 m cable  
 UA 1219 Accelerometer Mounting Kit  
 ZG 0423 DeltaTron Adaptor for Sound Level Meter

# ACCESSORIES, MODULES AND CALIBRATION

## **2260 Investigator includes:**

- 2260 Modular Real-time Analyzer with BZ 7210 Basic Sound Analysis Software
- AO 1442 Serial Interface Cable
- UA 0237 Windscreen, 90 mm
- BZ 5298 Environmental Software CD ROM

## **General accessories**

- UA 0237 Large Round Windscreen for 2260
- UA 0459 Small Round Windscreen for 2260
- UA 0801/UA 0587 Tripod for 2260
- UA 1317 Microphone/Preamplifier Holder for Tripod
- UA 1404 Outdoor Microphone Kit for 2260 (requires AO 0441/AO 0442)
- KE 0371 Carrying Case for 2260, 4231, 2322 Printer, UA 0801 Tripod, ZG 0387 Power Supply and Cables
- 2322 Portable Printer for 2260
- 3207 Tapping Machine

## **Mains Power Supplies**

- ZG 0386 EU Version
- ZG 0387 UK Version
- ZG 0388 US Version

## **Software and Modules for 2260**

- BZ 7203 Noise Profile and Level Recording Software
- BZ 7204 Building Acoustics Software
- BZ 7205 Sound Intensity Software
- BZ 7206 Enhanced Sound Analysis Software
- BZ 7207 Room Acoustics Software
- BZ 7208 FFT Software
- 1700 Human Vibration Front-end for 2260 Investigator
- WB 1438 Building Vibration Front-end for 2260 Investigator
- Memory (internal PC-card) upgrade to 32 Mbytes (UA 1450)

## **Miscellaneous Cables**

- AO 1442 Serial Interface Cable, linking 2260 to computer or serial printer
- AO 0440 AC Input/Output Cable
- AO 0441 3 m Microphone Ext. Cable
- AO 0442 10 m Microphone Ext. Cable
- JZ 0102 Adaptor 10-pin to 2 x 7-pin LEMO
- AR 0199 10-pin Flat Cable
- AO 0522 Headphones Adaptor
- JP 1041 Dual 10-pole Adaptor

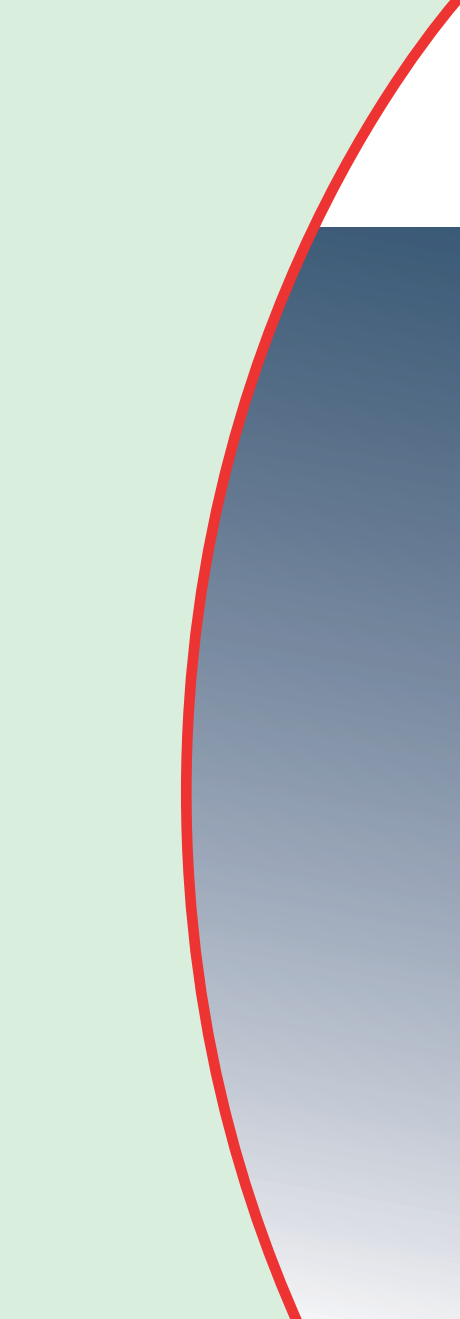

**HEADQUARTERS: DK-2850 Nærum · Denmark · Telephone: +45 4580 0500**

**Fax: +45 4580 1405 · [www.bksv.com](http://www.bksv.com) · [info@bksv.com](mailto:info@bksv.com)**

**Australia (+61) 2 9889-8888 · Austria (+43) 1 865 74 00 · Brazil (+55) 11 5188-8161**

**Canada (+1) 514 695-8225 · China (+86) 10680 29906 · Czech Republic (+420) 2 6702 1100**

**Finland (+358) 9 521300 · France (+33) 1 69 90 71 00 · Germany (+49) 421 17 87 0**

**Hong Kong (+852) 2548 7486 · Hungary (+36) 1 215 83 05 · Ireland (+353) 1 807 4083**

**Italy (+39) 0257 68061 · Japan (+81) 3 5715 1612 · Republic of Korea (+82) 2 3473 0605**

**Netherlands (+31) 318 55 9290 · Norway (+47) 66 77 11 55 · Poland (+48) 22 816 75 56**

**Portugal (+351) 21 4169 040 · Singapore (+65) 6377 4512 · Slovak Republic (+421) 25 443 0701**

**Spain (+34) 91 659 0820 · Sweden (+46) 33 22 56 22 · Switzerland (+41) 44 880 7035**

**Taiwan (+886) 2 2502 7255 · United Kingdom (+44) 14 38 739 000 · USA (+1) 800 332 2040**

**Local representatives and service organisations worldwide**



BG 1239 - 14